

3M Scotch® ATG 700

Adhesive Applicator

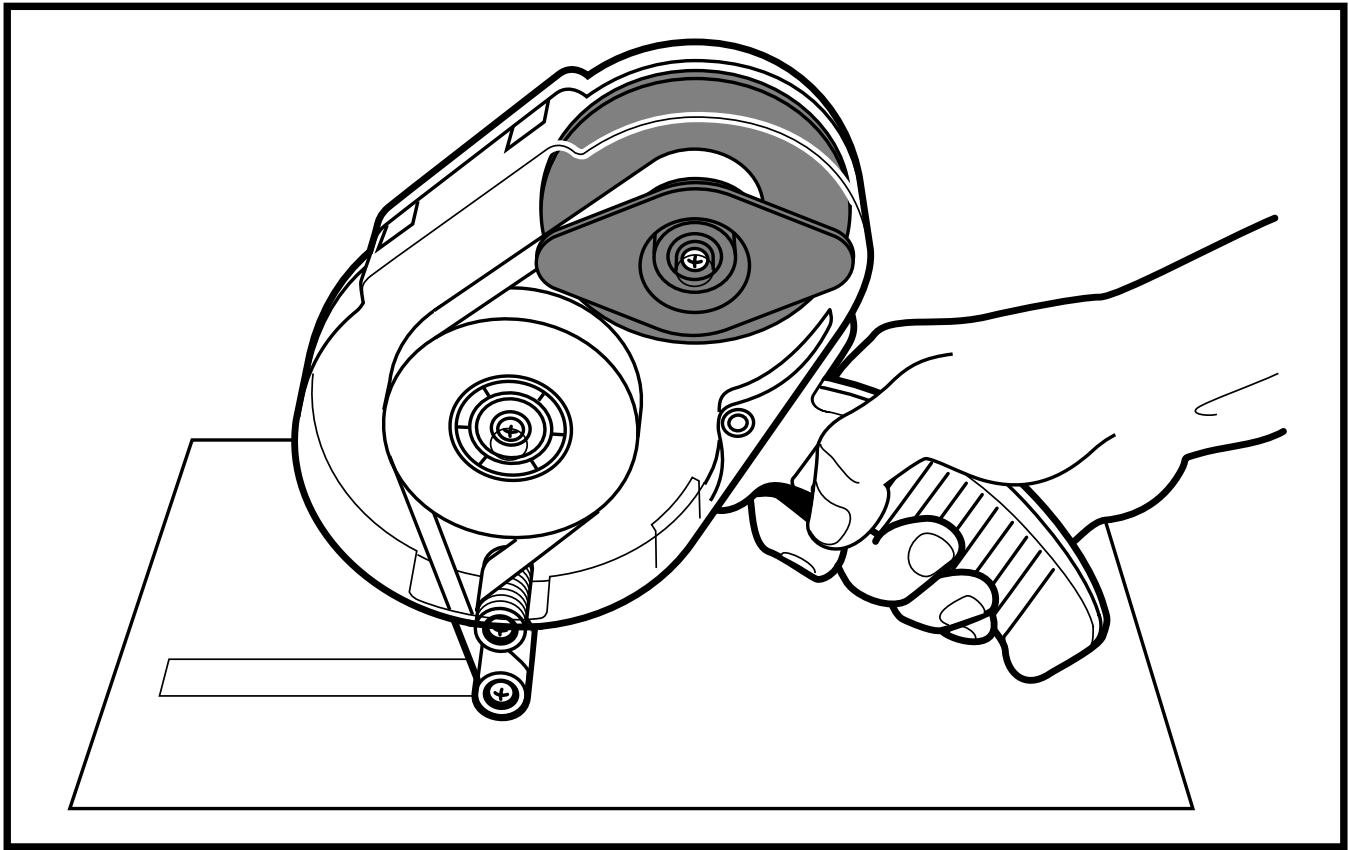

Applies adhesive while removing/rewinding liner.

Scotch® #	Metric
904	12 mm x 25 m 19 mm x 25 m 12 mm x 44 m 19 mm x 44 m
924	12 mm x 33 m 19 mm x 33 m 12 mm x 55 m 19 mm x 55 m
926, 969	12 mm x 16 m 19 mm x 16 m 12 mm x 33 m 19 mm x 33 m
928	12 mm x 16 m 19 mm x 16 m 12 mm x 33 m
976	12 mm x 55 m 19 mm x 25 m 19 mm x 55 m

With 1/4 Inch Adapter Kit:

ATG 1/4 Inch Adapter Kit available for 1/4 inch (6 mm) wide **Scotch®** Adhesive Transfer Tape.

Scotch® #	Metric
904	6 mm x 44 m
924	6 mm x 33 m 6 mm x 55 m
926, 969	6 mm x 33 m
976	6 mm x 55 m

Operating Instructions

1. Depress latch "A" and lift to open cover.

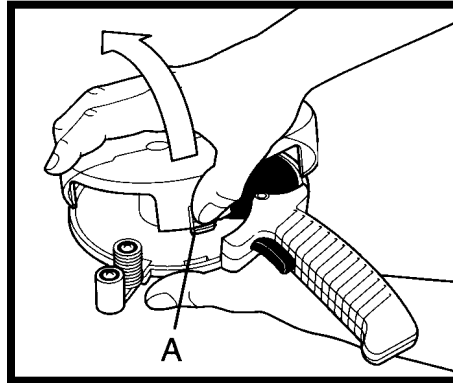

2. For 1/2 inch (12 mm) wide tape, leave tape roll spacer "B" in applicator. If using 3/4 inch (19 mm) wide tape, lift up and remove tape roll spacer from dispenser.

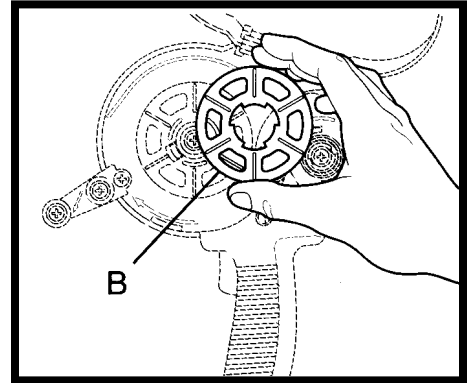

3. Hold rewind hub "C", rotate liner retainer "D" counterclockwise and lift up to remove.

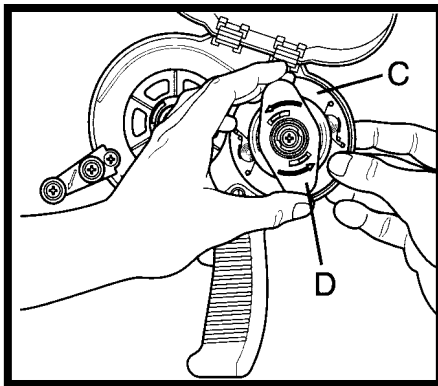

4. Place tape roll on three fingers of hub and press down until hook "E" locks tape roll in place.

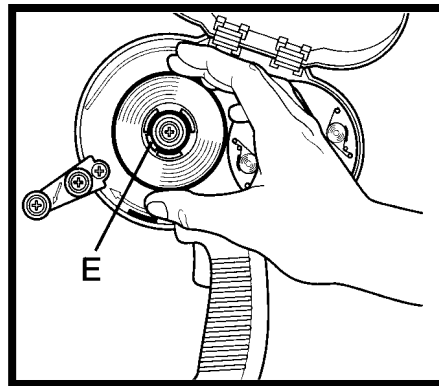

5. Depress trigger and thread tape leader as shown. Stop end of leader at point "F". Release trigger, replace rewind liner retainer and rotate clockwise to tighten liner. Close cover.

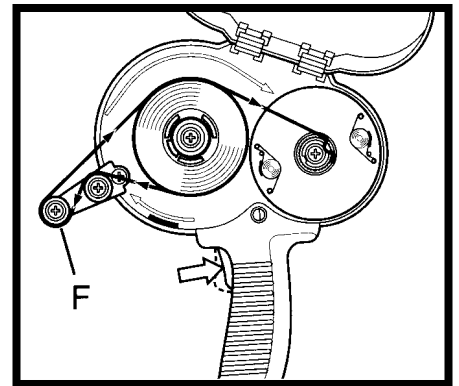

6. To start application: Place applying roller "G" on surface, depress trigger and pull applicator.

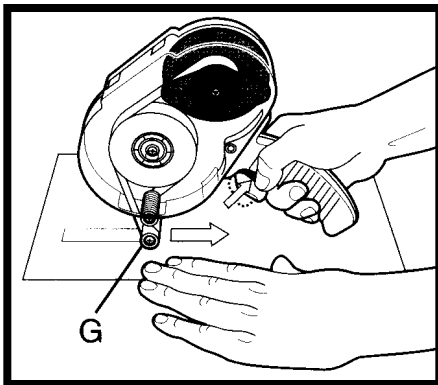

7. To end application: Keep applying roller on surface, stop, release trigger and pull applicator to break adhesive.

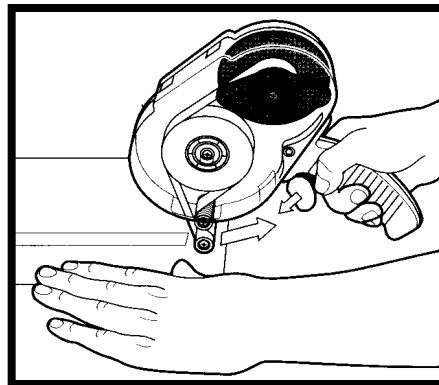

8. To remove rewound liner, rotate and remove liner retainer "D". Remove liner. To remove tape core, push hook "E" and remove tape core.

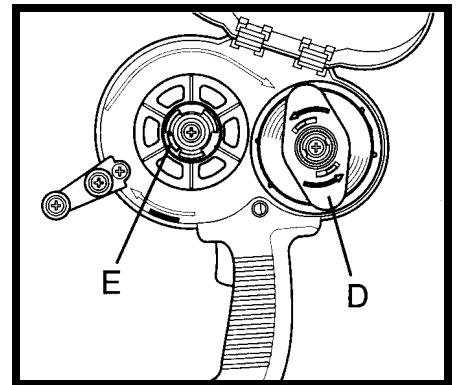

Lubrication/Cleaning

Lubrication – All shafts should be periodically lubricated with white petroleum jelly.

Cleaning – Dissassemble as required. Remove excess adhesive from applicator using 50/50 isopropyl alcohol and water solution.

Note: Follow the solvent manufacturer's precautions and directions for use when using solvents.

Important Notice: User is responsible for determining whether this 3M product is fit for a particular purpose and suitable for user's method of application. Test application prior use.

Limitation of Liability: 3M shall not be liable for any direct, indirect, special, incidental, or consequential loss or damage. Some states or countries do not allow the exclusion or limitation of incidental or consequential damages, so the above limitation or exclusions may not apply to you.

USA Replacement Parts

Ref. #	Part #
1	78-8111-1414-5
2	78-8018-7630-7
3	78-8111-1413-7
4	78-8113-6623-2
5	78-8113-6606-7
6	78-8113-6721-4
7	26-1012-0934-9
8	26-1002-4973-4
9	78-8111-1412-9
10	78-8113-6722-2
11	78-1012-0933-1
12	78-8111-1484-8
13	78-8113-6609-1
14	78-8111-1485-5
15	26-1002-5098-9

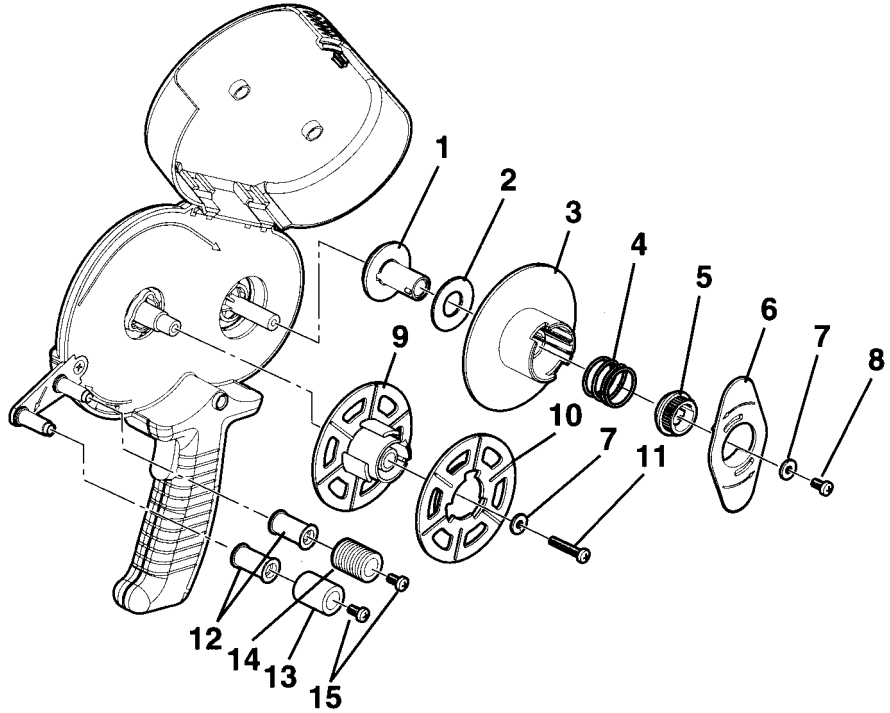

USA ordering information

Replacement parts and part prices available direct from:

3M Tape Dispenser Parts

241 Venture Drive 800/344-9883
Amery, WI 54001-1325 FAX # 715/268-8153

USA repair service ship direct to:

Tape Equipment Repair Services
241 Venture Drive
Amery, WI 54001-1325

Minimum billing on parts orders will be \$25.00.
Replacement part prices available on request.
\$10.00 restocking charge per invoice on returned parts.

For ordering information outside U.S.A., contact your local 3M subsidiary.



Industrial Business
Industrial Adhesives and Tapes Division

3M Center, Building 220-5E-06
St. Paul, MN 55144-1000

Printed in U.S.A.
©3M 2005 44-0009-1911-6 (2/05)